



**OPERATING
AND
SERVICING
INSTRUCTIONS
FOR
YOUR**

LUG-ALL®

Winch Hoist

LUG-ALL
MORGANTOWN, PA. 19543

*Since 1949 - More Than
5 Decades Of Excellence*



LUG-ALL values your opinions and comments. Please assist our continuous improvement plan by logging on to **LUG-ALL's** website and completing our on-line customer survey.

www.lug-all.com

For parts list drawings, log on to our website.

www.lug-all.com



WARNING

THE HOISTS DESCRIBED IN THIS BOOKLET ARE INTENDED FOR INDUSTRIAL USE AND NOT FOR LIFTING OR SUPPORTING HUMAN OR ANIMAL CARGO.

TABLE OF CONTENTS

LUG-ALL Model Number	4
Hoist Safety & You	5
Safe Hoisting Procedures	8
How To Operate Regular Lowering LUG-ALLs	12
Operating Instructions For The Rapid Lowering LUG-ALLs ..	13
Rigging Position	14
Suggestions For Rigging Your Car Door Puller	15
The Reversible Handle	15
Cable Return Crank	16

HOW TO TAKE CARE OF YOUR LUG-ALL

How to Take Care of Your LUG-ALL	17
Servicing Instructions For Regular Lowering LUG-ALL and LUG-ALL Car Door Pullers	18
Servicing Instructions For Rapid Lowering LUG-ALLs	21
Trouble Shooting	22
Servicing Instructions For Model 6000-15SH	23
Servicing Instructions for Models 2, 3, and 4	25
Limited Warranty Statement	28

You will need to know your LUG-ALL model number to order replacement parts. See the LUG-ALL parts list or the LUG-ALL website for correct part numbers.

FIND YOUR LUG-ALL MODEL NUMBER HERE

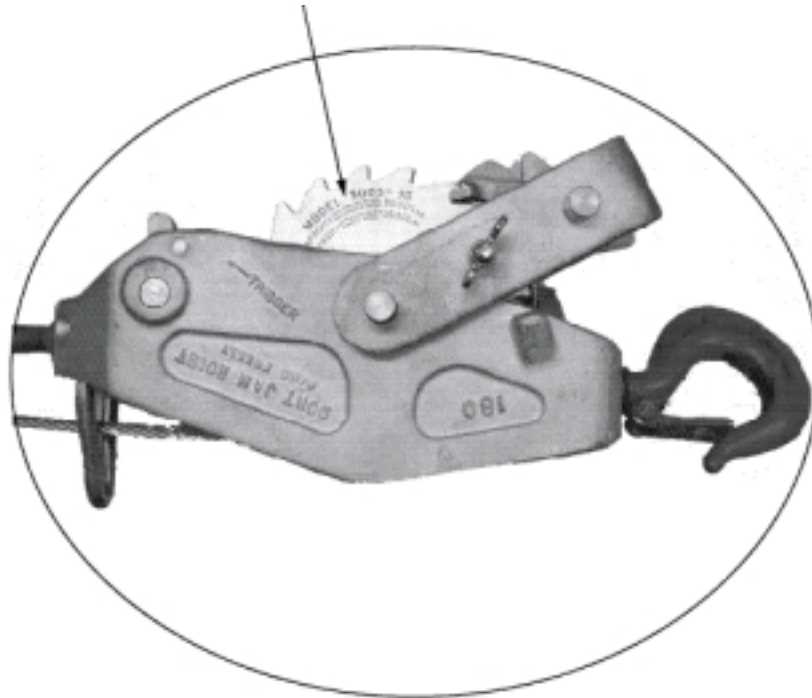

**MORGANTOWN BUSINESS PARK
604 HEMLOCK ROAD
MORGANTOWN, PA 19543
610-286-9884
FAX: 610-286-9661
www.lug-all.com
sales@lug-all.com**

HOIST SAFETY

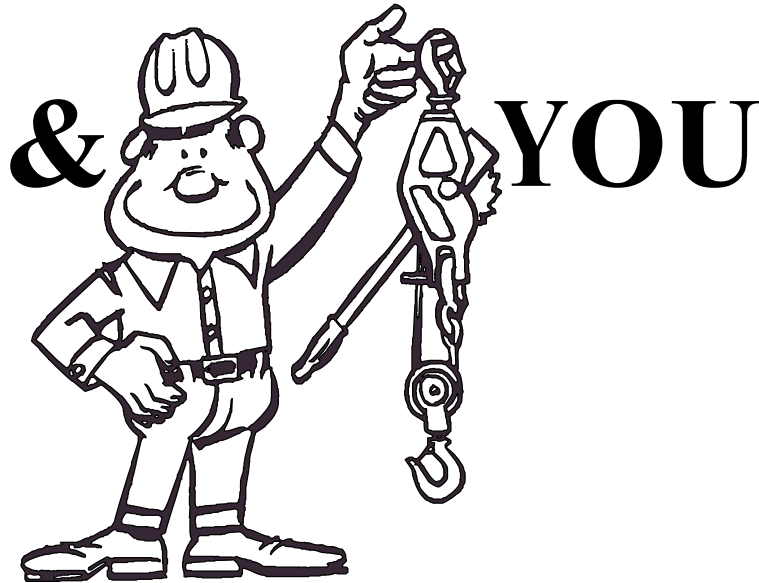

No matter how many safety features a manufacturer builds into a tool, true operational safety depends largely on the user. Like all other mechanical equipment, **LUG-ALL** must be properly operated and maintained to avoid risk of property damage or bodily injury.

Please do not attempt to operate your LUG-ALL until you carefully read the instructions and recommendations in this booklet. We also suggest that you save this booklet for reference in servicing your hoist.

Play it safe. Take good care of your **LUG-ALL** and it will reward you with many years of dependable, trouble-free service.

CAUTION!
use
common
sense
when you
use your
LUG-ALL

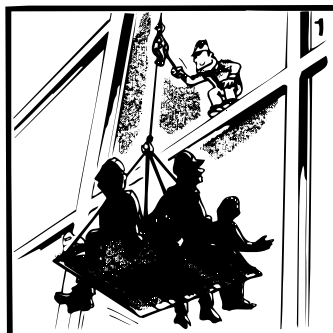

Never
use LUG-ALLs to
support human or animal
cargo in any manner

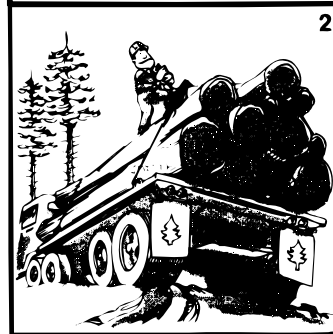

Never
use LUG-ALLs as load
binders

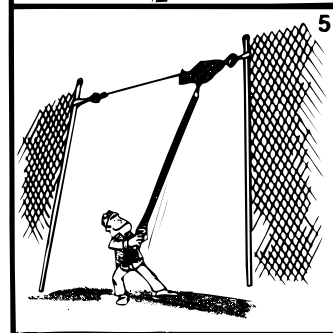
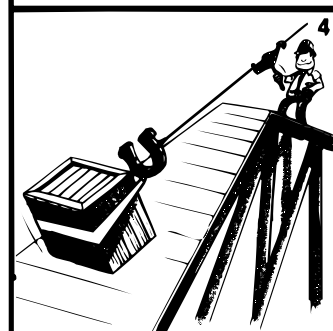
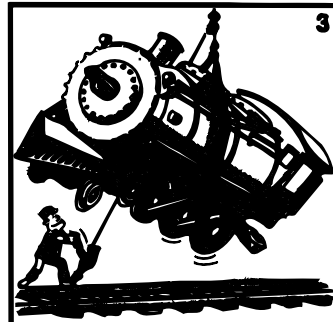

Never

load your **LUG-ALL** beyond rated capacity.

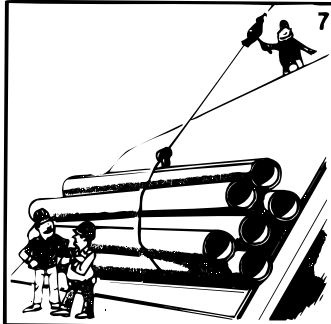

Never

use anything but factory-engineered **LUG-ALL** replacement parts.

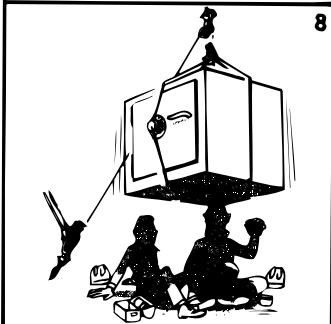

Never

lengthen, or make any substitution for the **LUG-ALL** reversible handle.

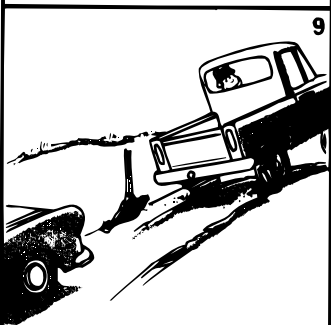

Never

let the **LUG-ALL** cable or webstrap come in contact with any other surface.

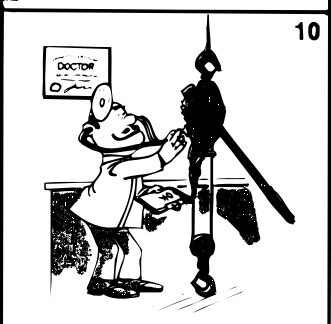

Never

use a **LUG-ALL** cable or webstrap as a choker.

Never

leave a load unattended and/or suspended in air.

Never

use a **LUG-ALL** as a tow line.

Never

fail to check your **LUG-ALL** before each use for damage, malfunction, or worn parts.

SAFE HOISTING PROCEDURES

1. *LUG-ALLs must never be used to support human or animal cargo in any manner.*

It is always unsafe to use a **LUG-ALL**, or **LUG-ALLs**, to lift or support humans or animals, or any type of scaffolding or vehicle on which humans are supported.

2. *LUG-ALLs must never be used as load binders.*

Resist the temptation to use your **LUG-ALL** as a load binder. You could be inviting trouble. It was not designed for this purpose and is not safe to use in this manner. The **LUG-ALL** hoist must always be operated with the cable or web strap in a straight line. The cable or web strap must never be wrapped around any object as this will damage the cable or web strap and may lead to future accidents.

3. *Never load your LUG-ALL beyond rated capacity.*

Cheating on capacities is a dangerous trick. Overloading a **LUG-ALL** can cause accidental injury to the operator, the hoist, or the load. It can also damage the hoist so that it may fail in the future.

The rated capacity of your **LUG-ALL** is clearly marked on the cable shield, and on the teeth side of the drum (It may be necessary to rotate the drum in order to bring the load capacity into view). If there is any doubt about the weight of your load, use the next larger capacity **LUG-ALL**.

4. *Use only factory-engineered LUG-ALL replacement parts.*

LUG-ALLs are precision engineered for dependable operation, and any substitution of parts, other than **LUG-ALL** factory parts, can seriously damage its safe performance. When repairing your **LUG-ALL**, replace any damaged member with a new **LUG-ALL** replacement part. It is unsafe to repair **LUG-ALL** components by heating, welding, bending, straightening, or any other means.

5. Never lengthen, or make any substitution for the LUG-ALL reversible handle.

The **LUG-ALL** reversible handle is designed to bend as a warning when the hoist is loaded at more than 100% capacity. If the handle should break through hoist overload or improper use, the **LUG-ALL** must not be used until a **LUG-ALL** replacement handle is obtained. Makeshift handles, or handle extensions are dangerous. They can increase the leverage so that the hoist may easily exceed its capacity without the user's knowledge and result in physical harm.

6. Keep the hoist cable or web strap free at all times and never let it come in contact with any other surface.

Always rig your **LUG-ALL** so that it hangs freely and can move from side to side. The cable or web strap should hang in a straight line between the top hook and the load hook. Never jam the frame out of the line as this subjects it to extra stress for uneven loading. Cable or web strap must be in a straight line to assure even wrapping on the drum.

Do not snag or pull the cable or web strap over sharp or rough edges as this will break the wires. Never bend the cable or web strap around any object or surface.

7. Observe safe rigging practices.

Become familiar with proper rigging practices before you operate your **LUG-ALL**. Consult the illustrations on pages 6 and 7 to protect against improper use of your **LUG-ALL**. All **LUG-ALL** ratings are based on freely suspended loads. **LUG-ALLs** cannot be safely used for side loading.

When rigging, always make sure that the load is securely seated in the throat of the hook before hoisting.

8. Stand clear of all loads. Never leave an unattended load suspended in air.

Most safety instructions are merely common sense. Stay alert and stay safe.

9. Never use your LUG-ALL as a tow line.

Your **LUG-ALL** must never be used for external loading. The **LUG-ALL** is designed only for applications where the safety handle is the controlling force in load movement. The safety handle must always be manually engaged for safe operation of your **LUG-ALL**.

10. Check your LUG-ALL periodically for damage, malfunction or worn parts.

You should examine your **LUG-ALL** before each use and thoroughly check it periodically for signs of damage or wear. Any imperfection in the hoist should be reported to your supervisor immediately. Under no circumstances should you operate a **LUG-ALL** that is not in good repair.

Inspect Hooks

Check hoist hooks carefully. If hooks are bent , or hook openings enlarged, the hoist should be removed from service until the hooks are replaced.

Latches on hooks should be carefully inspected to make sure that the latch is properly engaged. Damaged latches should be replaced immediately.

Inspect Cable

Examine cable for kinks, cuts, broken strands, fraying, or abrasions. The cable is not safe for use if any of these conditions exist in any degree (compare cable with that shown on page 11 for illustration of dangerous cable conditions). Note that cable must be replaced even though damage to cable appears minor.

Cable must be evenly wrapped around drum for safe hoist operation. Examine the cable to make sure it is properly seated in the pulley wheel.

Inspect Web Strap

Examine the web strap (where applicable) for cuts, fraying, broken stitches, or excessive wear. Replace if any of these conditions exist to a significant degree. **WARNING:** The web strap may have some insulating properties when it is clean and dry. It is NOT to be considered an insulating member. Use an appropriate insulating stick to achieve proper working distances.

Inspect for Cleanliness

The **LUG-ALL** is extremely easy to care for. Its open construction makes it simple to clean after use in mud, sand, or ice. Simply unwind the cable from the drum and flush the frame with water or steam.

Following these recommendations can add years of satisfactory service to the life of your **LUG-ALL**.

INSPECT YOUR LUG-ALL DAILY FOR THESE DANGEROUS CABLE CONDITIONS

Pictured here are examples of more obvious types of cable damage. These examples are intended to illustrate severely damaged cables. **Cables exhibiting damage of this sort to any degree should be replaced immediately.**

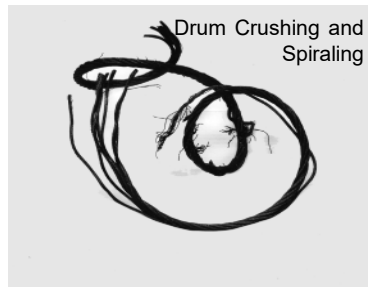

REPLACE THIS

Drum Crushing and Spiraling

The badly deteriorated condition of this cable clearly indicates that it is unsafe for operation. Cable damage of this type is usually caused by hoist abuse and by repeatedly overloading the hoist beyond its rated capacity. A hoist with this cable condition should not be used under any circumstances, and the cable must be replaced before the hoist can be safely operated.

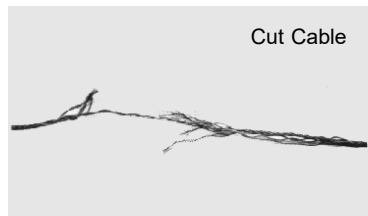

REPLACE THIS

Cut Cable

The condition of this cable indicates that it has been cut by a sharp object. This is apparent to the eye because several of the strands appear to be of equal length. It goes without saying that this cable must be replaced before the hoist can be safely operated.

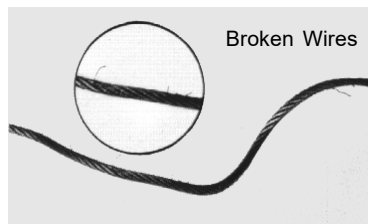

REPLACE THIS

Broken Wires

The frayed condition of this cable indicates broken wires and an unsafe condition. Cable deficiencies of this type are usually caused by abrasion. This can easily happen in a hoist operation if the operator allows the cable to come in contact with any other surface. This cable is considerably weakened and must be replaced before the hoist can be safely operated.

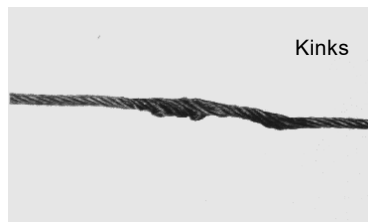

REPLACE THIS

Kinks

Kinks can result from improper uncoiling and unspooling, or they can be formed in hoist operation. Cable loops can occur in a slack line, or in a line under tension. If a loop occurs, it should be removed immediately. Otherwise the loop may be pulled through when tension is applied to the line and form a permanently deforming kink. Kinks in a cable are always dangerous as they create unequal tension in the rope and in the strands. A cable with kinks must be replaced before the hoist can be safely operated.

HOW TO OPERATE REGULAR LOWERING LUG-ALLS

These models have three actions:

1. Lifting or pulling
2. Lowering or backing off
3. Free release

The first two are completely automatic when the unit is under load. Setting the reverse lever (1) so it either holds the frame pawl against or away from the ratchet teeth (under spring tension) determines the action. **LUG-ALLS** will lower or back off *only* when under a load of 15 lbs. or more. Free release quickly unwinds the cable from the drum. It **will not** operate when the **LUG-ALL** is under load.

TO LIFT:

1. Set the reverse lever to hold the u-frame pawl *against* the ratchet teeth (Fig. 1).
2. Apply handle pressure (2) to lift one, two, three or a full stroke of the handle (four ratchet teeth).

TO LOWER: (requires load of 15 lbs. or more)

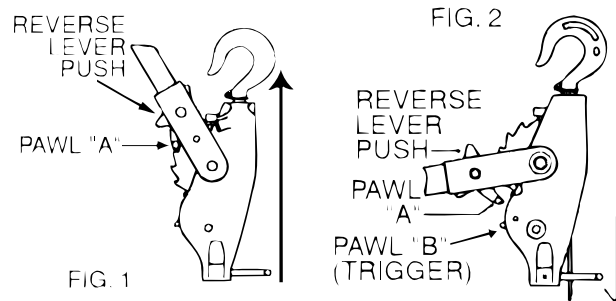

1. Set reverse lever to hold the u-frame pawl *away* from the ratchet teeth (Fig.2)
2. Move handle until u-frame pawl engages ratchet tooth. Additional handle pressure in the same direction will release the main frame pawl.
3. Ease off handle pressure and the load will lower one ratchet tooth. This action is similar to the operation of a bumper jack.

FREE RELEASE: (will not operate under load)

1. Set reverse lever to hold the u-frame pawl *away* from the ratchet teeth. (Fig. 2)
2. While pressing on the "trigger" to hold the main frame pawl *away* from the ratchet teeth-pull out the cable the required distance.

- (1) Older models have reverse discs instead of levers.
- (2) Up or down pressure is determined by position in which reversible handle is mounted.

OPERATING INSTRUCTIONS FOR THE RAPID LOWERING LUG-ALLs

The rapid lowering **LUG-ALL** models operate on the same basic principles as the regular lowering **LUG-ALLs** but have an additional action rapid lowering. A mechanism allows these models to lower four ratchet teeth per full stroke of the handle in addition to the notch-per-cycle regular lowering. The reliability and basic simplicity of the original unit is retained but the greater speed and smoothness in lowering offers an operational advantage. It is smoother because the starting and stopping of the load is reduced 75%.

TO LIFT:

1. Set the reverse lever to hold the u-frame pawl *against* the ratchet teeth (Fig. 1 page 15)
2. Place rapid lowering "switch" in the "OFF" position (ON and OFF positions are identified on the side of the main frame).
3. Apply handle pressure to lift one, two, three, or a full stroke on the handle (four ratchet teeth).

TO LOWER: (requires load of 15 lbs. or more)

1. For regular lowering (one ratchet tooth-per-stroke-of-the-handle) use the instructions on the previous page *plus* placing the rapid lowering "switch" in the "OFF" position.
2. For the rapid lowering (four ratchet teeth-per-stroke-of-the-handle) the same as for regular lowering except with the rapid lowering switch to the "ON" position.

IMPORTANT: When using rapid lowering the operator should position himself in such a way that he can control the torque of the handle through the full travel of the arc, which is four times longer than with the regular lowering. When first engaging rapid lowering the first stroke of the handle may lower from one to four ratchet teeth depending on the cam position. Following strokes will lower four ratchet teeth.

FREE RELEASE: (will not operate under load)

The same as for regular lowering models except with the rapid lowering switch is in the "OFF" position.

NOTE: See Handle and Rigging sections for other important information.

RIGGING POSITIONS

LUG-ALL Winch Hoists will operate in any position: right side up, upside down or at any angle as a hoist or horizontally as a winch. Rig double cable for full rated capacity (all models except ½ ton capacity, which are not equipped with pulley blocks), or single cable for one half rated capacity in any of the positions mentioned above.

When used single cable, the lifting distance and operating speed are doubled (except ½ ton which are not equipped with pulley blocks).

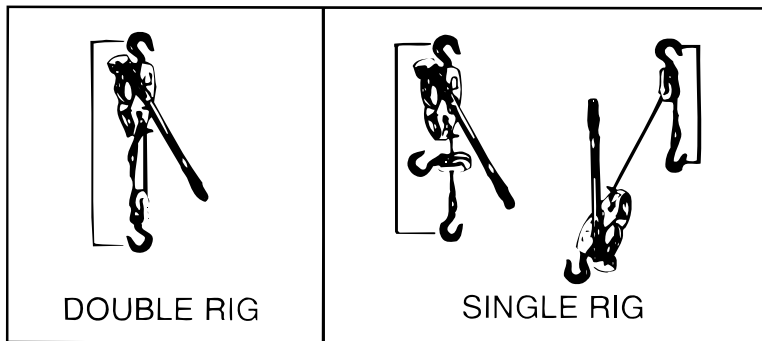

ALWAYS RIG YOUR LUG-ALL SO THAT IT WILL HANG FREELY AND BE FREE TO MOVE FROM SIDE TO SIDE. If the frame is jammed out of line it is subjected to undue stress from uneven loading and would not be free to move sideways which is necessary to allow even wrapping of the cable on the drum. Hooks should be placed so the point of contact is in line with the center of the shank or eye.

When rigging a **LUG-ALL** that will be used in rapid lowering it must be done so a full stroke of the handle is possible. For example, if working from a ceiling with the **LUG-ALL** right side up it would be necessary to use a choker or extension to lower the **LUG-ALL** sufficient distance to allow the handle to travel its full arc, which carries it above the top hook.

RIGGING YOUR CAR DOOR PULLER

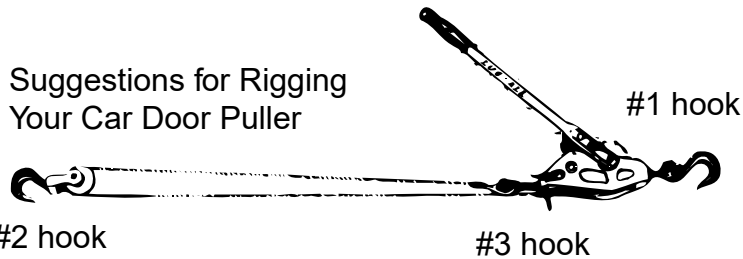

Because box cars vary as to length, door arrangements, etc., we want to point out different ways in which your **LUG-ALL** Car Door Puller can be rigged.

There are three hook arrangements: (the distances given apply to the Model HDR-30).

1. When used as shown above it has a 3000 lb. capacity with a 15 ft. pulling distance.
2. It can be rigged single capacity with the pulley block riding free, offering a 1500 lb. capacity and a 30 ft. pulling distance.
3. You can increase the double cable reach by using a three point attachment and still obtain a 3000 lb. capacity. Just make sure to locate the #2 hook towards the puller, so as to give double cable strength. After the door has moved some distance it may be necessary to relocate the #2 hook.

THE REVERSIBLE HANDLE

The handle is designed to bend before your **LUG-ALL** is dangerously overloaded. This protects the operator, the load and the hoist - thus avoiding the possibility of costly accidents. If the handle bends, the load should be backed off. The handle should then be replaced with a **LUG-ALL** factory replacement before any further use. Never use a makeshift or extended handle.

A steady application of pressure on the handle, rather than sudden, jerking pulls, will prolong its life. Impact loads should never be used to actuate a **LUG-ALL**.

The handle can be mounted to give either a downward or upward stroke to do your lifting and lowering. It is usually more desirable to do the lifting (or lowering) on a downward stroke of the handle. This is possible regardless of which way the hoist is rigged, either right side up or upside down.

If conditions require rigging in tight quarters where the handle movement is restricted in one position, it is likely that by reversing the handle there would be ample room to operate.

CAUTION: The handle should be pulled in the same plane of travel as the “leg” of the u-frame to which it is attached. **Sideward pull will bend the handle before it is actually overloaded and can break the wing nut or handle bolt; or bend the u-frame.**

IMPORTANT

When using rapid lowering, the operator should position himself so that he can control the torque of the handle through the full travel of the arc, as it is four times greater than when using regular lowering.

OPTIONAL CABLE RETURN CRANK

The cable return crank is available at extra cost on all models except 6000-15SH to allow quick and easy return of slack cable to the drum. It is especially useful on long cable models. The crank is easily detached when it is necessary to use your **LUG-ALL** in close quarters. The crank should *not* be used for raising or lowering loads as its short length provides very limited leverage. A shear pin protects against dangerous overloading.

Crank conversion kits are available for all models, except 6000-15SH.

- 1. To Place crank on shaft:** Pull out shear pin until it does not obstruct shaft hole and slide crank on drum shaft. Push in shear pin until its end rides in groove on shaft thus captivating it.
- 2. To engage crank for rewinding cable:** After above, rotate crank while pressing on shear pin until end of pin enters hole in groove on shaft. To rewind turn crank *counter* clockwise.
- 3. To disengage crank after rewinding:** Pull shear pin out far enough to allow crank to rotate on shaft but is still captivated on it.
- 4. To remove crank from shaft:** Pull out shear pin while turning it 1/8 turn until crank is free to slide off of shaft.
- 5. To replace shear pin:** Same as 4 but pull pin completely out. New pins are available at nominal cost.

NOTE: Always have light tension on the cable when rewinding to assure tight, even wrapping on the drum.

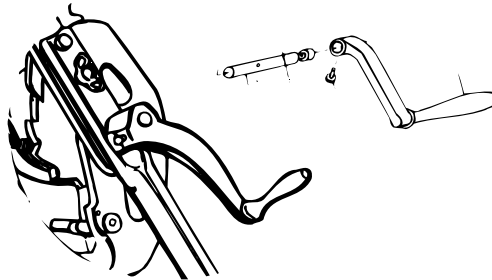

HOW TO TAKE CARE OF YOUR LUG-ALL

Your **LUG-ALL** is designed to give you many years of satisfactory performance if used properly. Always hang it freely with a straight line between top hook (No. 1) and load hook (do not jam against a stationary object). And remember, **LUG-ALL** hoists are intended for industrial use, not for lifting or supporting human or animal cargo.

The **LUG-ALL** is extremely easy to care for. Its open construction makes it simple to clean after use in mud, ice, sand or other extreme conditions. Strip the cable from the drum and flush it out with water or steam. A quick check of its working parts takes only seconds. You can add years to its life by following these recommendations.

1. Do not snag or pull the cable over sharp or rough edges as this will break the wires. **LUG-ALLs** are equipped with high quality cable, and with reasonable care will give satisfactory service.
2. When rewinding the cable on the drum, apply light (10 lbs.) tension. This assures even wrapping and will prevent the cable from “wedging” the next time it is used under heavy load.
3. Stop pulling when cable clamp reaches cable guide or pulley wheel, or pulley wheel reaches cable guide (depending on rig used), as continued pulling will damage parts.
4. To operate the **LUG-ALL**, use a steady, straight pull. See “The Reversible Handle” Page 12.
5. When operating the **LUG-ALL** under load, do not allow the handle to “fly” as this can cause damage to the u-frame.

See “ Rigging Positions” Page 11 for other useful information which, if followed, will extend the service life of your LUG-ALL.

SERVICING INSTRUCTIONS FOR REGULAR LOWERING LUG-ALL WINCH HOISTS AND LUG-ALL CAR DOOR PULLERS

Field servicing is simple and practical. The **LUG-ALL's** advanced design, allows service work to be done in the field or in your shop. Only snap rings and locking pins securely lock the hoist together.

The model number (see page 4) is needed to order the correct parts. It is located on the ratchet side of the drum in an arc below the teeth. Rotation of the drum may be necessary to view the model number.

SERVICING INSTRUCTIONS FOR REGULAR LOWERING LUG-ALL WINCH HOISTS AND LUG-ALL CAR DOOR PULLERS

Cable Assembly

To remove cable:

1. Unreel cable from drum. (It is not necessary to remove cable shield to replace cable).
2. If cable is not broken (but frayed, whiskered, etc.) cut clean. If to be reused, cut at cable clamp.
3. Slip old cable out through drum.
4. Cut eye hook from cable and save for installation on replacement cable.

To replace cable:

1. Thread cable first through the drum (start on counter-bored side Fig. 1), then through cable guide, pulley block, cable clamp and then over thimble placed thru eye of hook. The cable is then brought back through the cable clamp. Allow enough cable around thimble to install cable clamps.
2. Draw cable tight around thimble and have cable clamp at the end of the thimble, then tighten. If fist grip cable clamps are used (Fig. 2), two are required to be placed six cable diameters. apart. Nuts on clamps should be retightened after initial load is applied.



Main Frame Assembly

To Remove the drum and/or the u-frame:

1. Remove the handle and unreel cable from the drum.
2. If the drum is to be replaced, cut cable at eyehook and slip out through the drum.
3. Drive out the 1/8" locking pin that locks the drum to the drum shaft.
4. Drive out the drum shaft. The drum and u-frame are now free.

To replace drum and/or u-frame:

If a new u-frame is to be used, follow steps on page 15 to complete that assembly before installing on the main frame

1. Place main frame so the name **LUG-ALL** cast on the side at the top is on the left.
2. Slip the drum into the cable shield on the main frame with ratchet teeth to the right. If new drum is used thread the cable through drum, (starting on the counter-board side) before placing in position.
3. Slip u-frame into place with the right side on the outside of the main frame, and the left side between drum and the main frame. Position u-frame so that pawl is on the right side. See Fig. 3.
4. Align holes of the drum, u-frame and the main frame. A rounded pilot is helpful.
5. Slip drum shaft into place with small locking pin hole to left of center and parallel with matching hole in the hub of the drum.
6. Drive shaft in until locking pin holes are even, then drive in locking pin.



Fig. 3

To remove cable shield.

1. Unreel the cable.
2. Lift retaining ring from position by placing screw driver under edge and force out of groove.
3. Press down on cable shield to free cable shield pin, then slide shield around drum and remove.

To remove main frame pawl spring #131:

1. Place point of screw driver in loop of spring (#1 end) at spring anchor and pawl stop position. Pick up tension of spring with screw driver.
2. Slip loop past spring anchor and release slowly.
3. Slip loop at other end off spring anchor pin on main frame pawl.
4. Spring then can be removed.

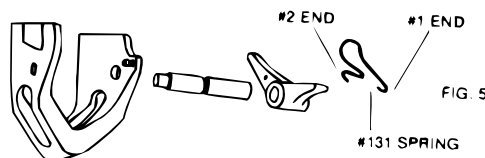

To replace main frame pawl spring #131:

1. Place #2 end of spring between ratchet wheel of drum and the main frame, with the large hoop of the spring facing #1 hook position.
2. Hook the loop on the #2 end over spring anchor pin on the main frame pawl.
3. Place screw driver in loop at #1 end, then draw beyond the spring anchor on the main frame.
4. Ease tension on the spring so the #1 end will be secure on the spring anchor on the frame.

Removal and replacement of main frame pawl spring #200

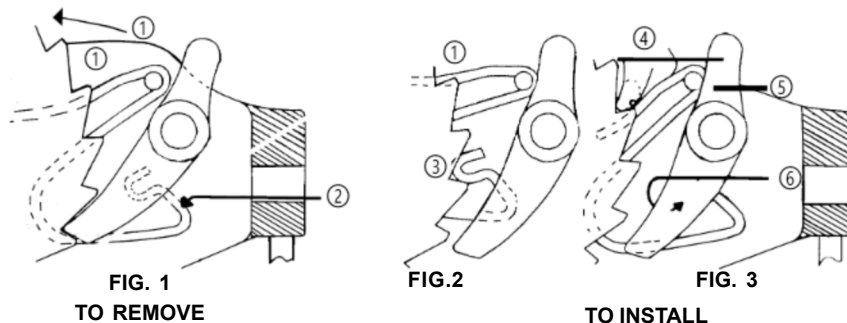

- ① SWING U FRAME AWAY FROM SPRING IN FIG. 1 & 2
- ② LOOP SNAPS OFF PIN, PUSH HERE TO REMOVE
- ③ INSERT SPRING BETWEEN RATCHET & MAIN FRAME AS SHOWN
- ④ SWING U FRAME TOWARD SPRING & PRESS DOWN
- ⑤ WITH LOOP SNUG
- ⑥ UNTIL THIS LOOP SNAPS ON ANCHOR PIN

To remove main frame pawl and pawl shaft:

1. Remove snap washer by placing screw driver point at each end and force out of groove.
2. Drive out main frame pawl shaft from the small hole end.
3. The main frame pawl, spring and shaft are then free. **Note:** On a main frame pawl replacement the spring anchor pin is included and supplied attached to the new pawl.

To replace main frame pawl and main pawl shaft:

1. Place frame so the name **LUG-ALL** cast on the side at the top is on left.
2. Place loop of spring at #1 end on spring anchor on the main frame with the hoop of the spring between the ratchet wheel and the frame.
3. With trigger end of pawl toward you, place spring anchor pin in loop at #2 end of spring.
4. Pressing down on the pawl align the hole with those in the frame and insert the shaft, shouldered end first.
5. Replace the snap washer.

U-frame Assembly

It is not necessary to remove the u-frame assembly from the main frame to replace the u-frame pawl, spring, shaft, reverse lever, spring support roll or retaining washer. It must be removed to replace the handle bolt.

To remove pawl, shaft, spring and/or reverse lever:

1. Remove shaft snap washer.
2. With reverse lever in "Down" position, slide spacer washer, reverse lever and pawl to the left (opposite side of shaft).
3. Slide shaft to the right and remove.
4. All of the parts above, including the spring roller, are now free.

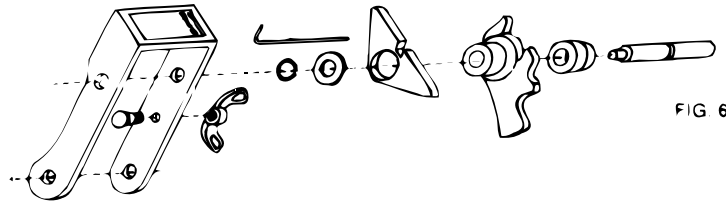

To replace pawl, shaft, spring and/or reverse lever:

1. Insert shaft halfway, shouldered end first, through hole in handle bolt side of u-frame.
2. Insert small end of u-frame pawl spring in hole in u-frame.
3. Slide spring roller on shaft with beveled side against leg of u-frame.
4. Place reverse lever on pawl so that the spring can pass through the notch in the lever and the saddle formed by the two projections on the pawl, and slide onto shaft while holding spring in position. **Note:** Be certain the short end of spring is inserted in the hole as far as it will go.
5. Hold spacer washer in position and slide shaft into final position.
6. Slide parts on shaft to final position by holding down on front end of pawl so projections will clear stop on u-frame.
7. Replace shaft snap washer.

SERVICING INSTRUCTIONS FOR RAPID LOWERING LUG-ALLS

Rapid lowering **LUG-ALLs** are identified by the suffix "R" in the model number. The repairing of these models differs only slightly from the regular lowering **LUG-ALLs** due to the main frame pawl being pinned to the main frame pawl shaft, the addition of the rapid lowering assembly, and the cam on the drum flange.

RAPID LOWERING ASSEMBLY

The rapid lowering assembly is supplied as a complete unit.

TROUBLE SHOOTING

If your LUG-ALL will not lower or back off automatically, the following tests can be made:

1. Inspect cable on drum to see that it is not “wedged” or “jammed”. Test by operating free release (see page 12).
2. Examine u-frame pawl spring. With the reverse lever in lifting position spring should hold pawl *against* ratchet teeth. In lowering position spring should hold pawl *away* from the ratchet teeth.
3. Check button on side of u-frame pawl for excessive wear. Its width should be approximately 1 ½ times the diameter of the main frame pawl spring. Place reverse lever in lowering position, move u-frame until pawl button comes in contact with spring. If the button is not worn excessively and slips past the spring, its alignment can be corrected by placing a spacer washer between u-frame pawl and snap ring.
4. If, in the above test, the pawl button contacted the main frame pawl spring and guided the u-frame pawl in to the ratchet wheel, then test the main frame pawl spring for fatigue. With the reverse lever in lowering position and the hoist under light tension, place handle in full lowering position so the u-frame pawl engages the ratchet wheel. If the main frame pawl does not release continue pressing on the handle and at the same time press on the “trigger”. If “trigger” pressure releases the main frame pawl, but spring pressure does not, it indicates the spring is fatigued and should be replaced.
5. If, when the above test is made, pressure on the “trigger” does not release the main frame pawl, test the u-frame pawl for excessive wear. To test, place an object (knife blade, nail, paper clip, etc.) between the u-frame pawl and the tooth it would normally engage for lowering. If it lowers one notch under this test with the unit under light tension then the trouble is located. This condition is more likely to develop after a **LUG-ALL** has been repaired and a new main frame pawl installed but not a new u-frame pawl. Under normal conditions the two pawls wear evenly and seldom give any difficulty.
6. Check both u-frame and main frame pawls for “snappy” spring action. Sluggish action can result from dirt or corrosion on the shafts and in the shaft holes. Remove shafts and clean with fine steel wool. Clean shaft holes in pawls, u-frame and main frame (equipped with oilite bearings on rapid lowering models). Apply light oil on all bearing surfaces and reassemble.
7. Check to see that both pawls engage solidly at the base of the ratchet teeth in both lifting and lowering cycles.
8. If main frame pawl on rapid lowering model does not fully engage, check actuating pin and edge of projection on rapid lowering assembly that engages the actuating pin to see if it is bent.
9. The u-frame pawl should align with the ratchet teeth, if it does not check to see if the u-frame is twisted from someone having let go of the handle while handling a load.

INSTRUCTIONS FOR MODEL 6000-15SH

In addition to the features found on all **LUG-ALL** Winch Hoists, your Model 6000-15SH has the following special features which you should be aware.

The handle socket can be moved to either of two positions. Lifting or pulling and many lowering or backing off operations can be easily accomplished with the socket in the standard position parallel to the edge of the u-frame. To lower or back off heavy loads, you may want to have the socket in the other position; this affords a better leverage angle, and allows lowering and backing off to be done more easily. To move the handle socket from one position to the other, simply remove the socket cap screw with a $\frac{5}{16}$ " hex key, slide the socket to the proper position, and reinsert the screw.

The reversible telescoping handle is aligned in the handle socket by a pin $5\frac{1}{2}$ " from its end and is fastened in place by tightening the thumb screw on the socket.

To telescope the handle, loosen the handle locking nut (right hand thread), slide the smaller tube to the desired position, and retighten the handle locking nut by hand. Do not use a wrench.

The shear pin between the handle socket and u-frame is designed to break if the Winch Hoist is seriously overloaded. The shearing of the pin will be readily apparent from the sharp report when it snaps and the looseness of the socket. While the Winch Hoist does not become inoperative when the pin is sheared, an overload condition exists and the unit should not be used until measures have been taken to reduce the load. If it is not possible to reduce the load and the overload condition is minor, the stops on the u-frame will allow you to complete your immediate operation. **DO NOT BEGIN A SUBSEQUENT OPERATION BEFORE REPLACING THE BROKEN SHEAR PIN!**

To replace shear pin: (1) remove the handle from the socket ; (2) push the pieces of the broken shear pin out from the u-frame side with a small hex wrench, a nail, or other small shaft; (3) push the replacement shear pin into place with your fingers. It is easier to replace the shear pin if the screw holding the handled socket is loosened first.

**Regular Handle Position
(with hand)**

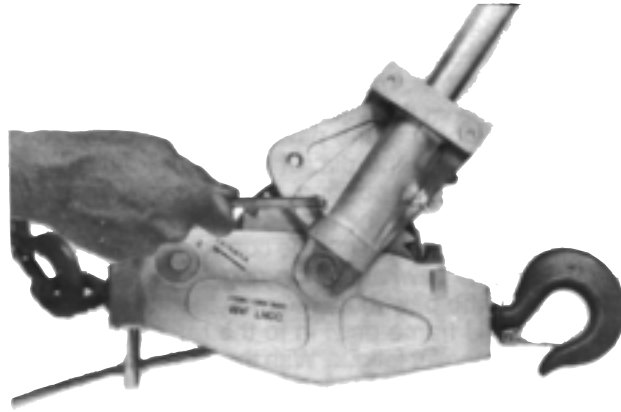

**Handle Position for extra
leverage in backing-off
heavy loads**

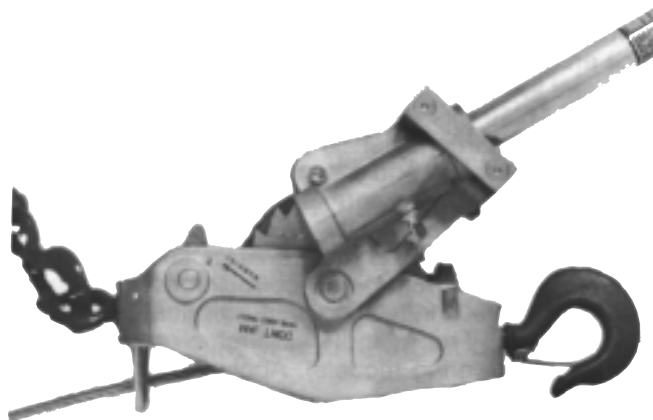

LUCALL®

SERVICING INSTRUCTIONS FOR MODEL 2, 3 AND 4

These are models equipped with fiberglass handles and nylon web straps which may have some insulating properties when the straps are clean and dry. Straps and handles should not be considered insulated members. Use an appropriate insulating link stick to achieve proper working distances.

The repairing of these models is the same as for the regular lowering models except for replacing the web strap, the web guide and repairs that can be made to the "repeater" safety valve handle. Each **LUG-ALL** web strap hoist is equipped with a stress link that signals to warn you of a dangerous overload.

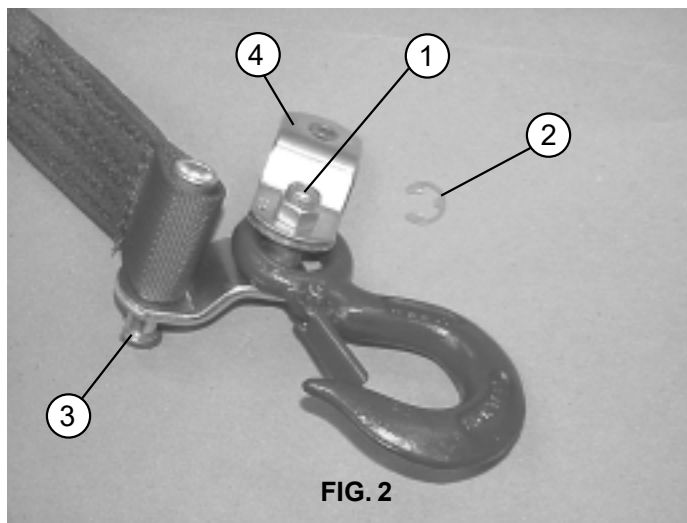
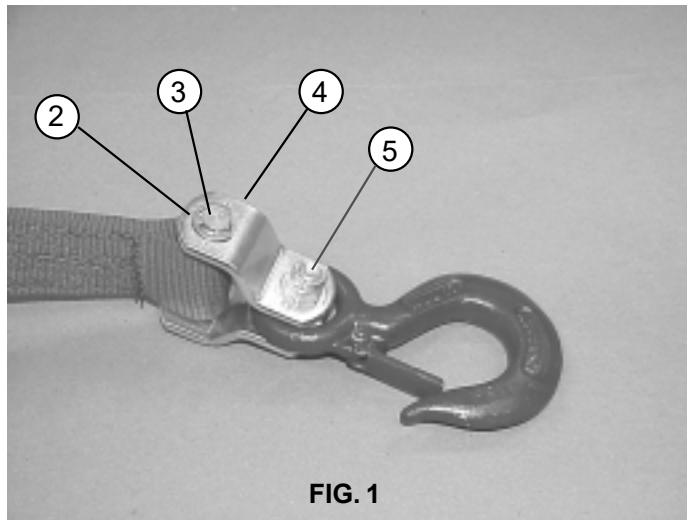

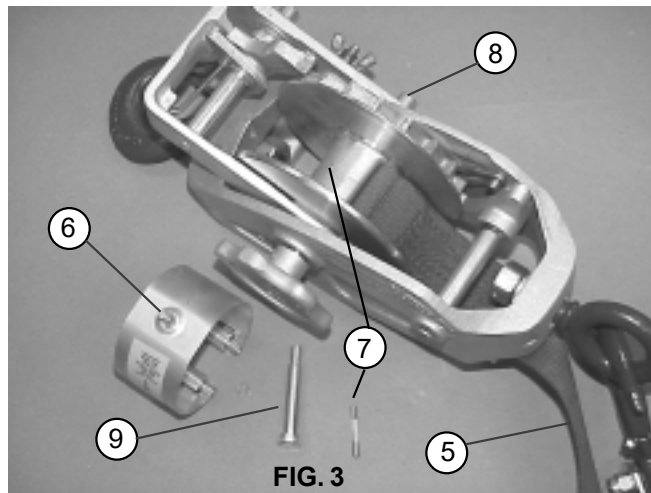

Instructions for Replacing Web Strap:

1. Loosen #528 hook attachment nut about 1 turn.
 2. Remove # 347 retaining ring from one end of web attachment pin.
 3. Push #524 web attachment pin through side link.
 4. Swing #523 side link and slip web strap off the #525 bushing.
- The four above steps will remove the Hook Assembly.**

5. Reel web strap off drum as far as possible.
6. Remove #520 web shield assembly.
7. Drive out #134 drum shaft locking pin.
8. Drive out #194 drum shaft far enough to allow removal of drum.
9. Remove #512 drum anchor screw and remove web.

To insert new web, reverse the above operations---but be sure to:

- a. Insert end of web with short stitched side against hub of drum.
- b. Thread web strap through web guide and pulley block before assembling hook.
- c. **IMPORTANT: Tighten #528 hook attachment nut securely as last operation.**

To Remove Handle Side Bar and/or Handle Socket:

1. Remove link pin nuts and link pins to remove stress link and overload link.
2. Drive out pivot pin for socket and side bar to separate them.

To Replace Stress Link:

1. Remove threaded link pin nuts located on the handle casting into which the fiberglass tube is inserted.
2. Install new stress link and reverse above operation.

NOTE: Use one stress link and one overload link; the use of two overload links would provide excessive strength and eliminate the “safety” valve action of the handle.



WARNING

The web strap of this hoist is made of synthetic fibers, and like all fibers, whether synthetic or natural, it is subject to deterioration from many and various causes, including chemical elements, weather and exposure to sunlight.

If the use of this puller requires its exposure to deteriorating conditions, the web strap should be tested periodically and replaced when the safety factor for its maximum possible load is considered to be insufficient by the user.

Inspection Criteria for Synthetic Web Straps

Remove from service if any of the following is visible:

- Strap shows signs of melting, charring or chemical damage.
- Cuts on the face or edge of webbing.
- Holes, tears, snags or crushed web.
- Signs of excessive abrasive wear.
- Broken or worn threads in the stitch patterns
- Any other visible damage which causes doubt as to its strength.

Most of the damage described above would cause immediate catastrophic failure of the strap. Not all of the damage you will see will be obvious or extreme, but still requires removal from use.

LIMITED WARRANTY

Seller warrants that the **LUG-ALL** described is free from defects in material and workmanship for a term of one year from the date of purchase by the original consumer. IN THE EVENT OF A DEFECT, MALFUNCTION OR OTHER FAILURE OF THE **LUG-ALL** PRODUCT NOT CAUSED BY UNREASONABLE USE, FAILURE TO PROVIDE REASONABLE AND NECESSARY MAINTENANCE OR DAMAGE TO THE PRODUCT WHILE IN THE POSSESSION OF THE CONSUMER, THE SELLER WILL REMEDY THE DEFECT OR FAILURE WITHIN 30 DAYS OF RETURN TO SELLER AT THE ADDRESS SPECIFIED BELOW. THE REMEDY WILL CONSIST SOLELY OF REPAIR OR REPLACEMENT OF THE PRODUCT AT THE SELLER'S OPTION. IF AFTER A REASONABLE NUMBER OF ATTEMPTS BY THE SELLER TO REMEDY THE DEFECT, MALFUNCTION OR OTHER FAILURE AND THE REMEDY FAILS OF ITS ESSENTIAL PURPOSE, THE CONSUMER IS ENTITLED TO ELECT EITHER A REFUND OR A REPLACEMENT, WITHOUT CHARGE.

This warranty does not apply to defects caused by modification, alteration, repair or service of the **LUG-ALL** by anyone other than **LUG-ALL**. The warranty extends to only the original purchaser of the **LUG-ALL**.

In order to obtain performance under the warranty, the consumer must deliver the **LUG-ALL** and all ancillary parts thereto to **LUG-ALL at 604 Hemlock Road, Morgantown Business Park, Morgantown, PA 19543, together with written explanation of the defect or failure (Telephone – 610-286-9884; Fax – 610-286-9661)**. Delivery expenses and insurance for warranty service to and from **LUG-ALL** are the responsibility of the Buyer. Proof of purchase, such as sales receipt or other documentation is required when requesting warranty service.

THIS WARRANTY GIVES YOU SPECIFIC LEGAL RIGHTS, AND YOU MAY ALSO HAVE OTHER RIGHTS THAT VARY FROM STATE TO STATE.

IN NO EVENT SHALL SELLER (INCLUDING ITS AFFILIATES, SUBSIDIARIES, CONTRACTORS, DIRECTORS, EMPLOYEES AND AGENTS) BE LIABLE FOR ANY CONSEQUENTIAL, INCIDENTAL, ECONOMIC, DIRECT, INDIRECT, GENERAL OR SPECIAL DAMAGES OF ANY KIND, INCLUDING, WITHOUT LIMITATION, LOST BUSINESS, LOST SAVINGS, LOST DATA AND LOST PROFITS, REGARDLESS OF THE CAUSE AND WHETHER ARISING IN CONTRACT (INCLUDING FUNDAMENTAL BREACH), TORT (INCLUDING NEGLIGENCE), OR OTHERWISE, EVEN IF THE SELLER HAS BEEN ADVISED OF THE POSSIBILITY OF SUCH DAMAGES. SOME STATES DO NOT ALLOW THE EXCLUSION OR LIMITATION OF INCIDENTAL OR CONSEQUENTIAL DAMAGES, SO THE EXCLUSION OR LIMITATION IN THIS PARAGRAPH MAY NOT APPLY TO YOU.

Buyer shall notify Seller promptly, and in any event within thirty (30) days of its becoming aware of any accident or malfunction involving Seller's products that arise out of or relate to any personal injury or damage to property and shall cooperate fully with Seller in investigating and determining the cause of such accident or malfunction. To the extent that Buyer fails to give such notice to Seller and provide such cooperation, Buyer shall be liable to Seller for the consequences of such failure.